

NDF05N50Z, NDP05N50Z, NDD05N50Z



ON Semiconductor®

<http://onsemi.com>

N-Channel Power MOSFET 500 V, 1.25 Ω

Features

- Low ON Resistance
- Low Gate Charge
- 100% Avalanche Tested
- These Devices are Pb-Free and are RoHS Compliant

ABSOLUTE MAXIMUM RATINGS (T_C = 25°C unless otherwise noted)

Rating	Symbol	NDF	NDP	NDD	Unit
Drain-to-Source Voltage	V _{DSS}	500			V
Continuous Drain Current R _{θJC}	I _D	5 (Note 1)	5	4.7	A
Continuous Drain Current R _{θJC} , T _A = 100°C	I _D	3.2 (Note 1)	3.2	3	A
Pulsed Drain Current, V _{GS} @ 10 V	I _{DM}	20 (Note 1)	20	19	A
Power Dissipation R _{θJC}	P _D	28	96	83	W
Gate-to-Source Voltage	V _{GS}	±30			V
Single Pulse Avalanche Energy, I _D = 5.0 A	E _{AS}	130			mJ
ESD (HBM) (JESD22-A114)	V _{esd}	3000			V
RMS Isolation Voltage (t = 0.3 sec., R.H. ≤ 30%, T _A = 25°C) (Figure 15)	V _{ISO}	4500			V
Peak Diode Recovery	dv/dt	4.5 (Note 2)			V/ns
Continuous Source Current (Body Diode)	I _S	5			A
Maximum Temperature for Soldering Leads, 0.063" (1.6 mm) from Case for 10 s Package Body for 10 s	T _L T _{PKG}	300 260			°C
Operating Junction and Storage Temperature Range	T _J , T _{stg}	-55 to 150			°C

Stresses exceeding Maximum Ratings may damage the device. Maximum Ratings are stress ratings only. Functional operation above the Recommended Operating Conditions is not implied. Extended exposure to stresses above the Recommended Operating Conditions may affect device reliability.

1. Limited by maximum junction temperature
2. I_S = 4.4 A, di/dt ≤ 100 A/μs, V_{DD} ≤ BV_{DSS}, T_J = +150°C

V _{DSS}	R _{DS(on)} (TYP) @ 2.2 A
500 V	1.25 Ω

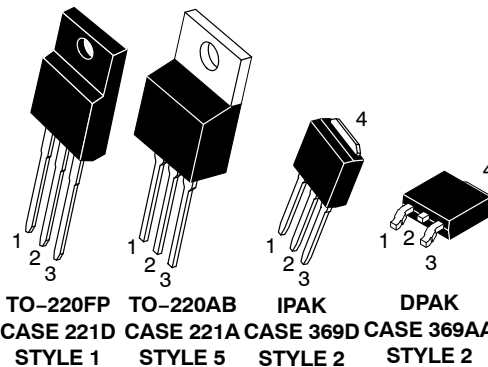
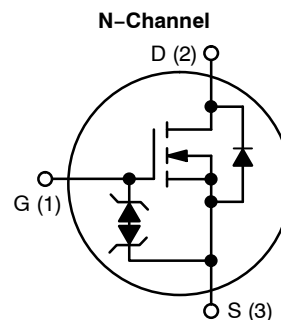

MARKING AND ORDERING INFORMATION

See detailed ordering and shipping information in the package dimensions section on page 6 of this data sheet.

NDF05N50Z, NDP05N50Z, NDD05N50Z

THERMAL RESISTANCE

Parameter	Symbol	Value	Unit
Junction-to-Case (Drain)	NDP05N50Z	1.3	°C/W
	NDF05N50Z	4.4	
	NDD05N50Z	1.5	
Junction-to-Ambient Steady State	(Note 3) NDP05N50Z	50	
	(Note 3) NDF05N50Z	50	
	(Note 4) NDD05N50Z	38	
	(Note 3) NDD05N50Z-1	80	

3. Insertion mounted

4. Surface mounted on FR4 board using 1" sq. pad size, (Cu area = 1.127 in sq [2 oz] including traces).

ELECTRICAL CHARACTERISTICS (T_J = 25°C unless otherwise noted)

Characteristic	Symbol	Test Conditions	Min	Typ	Max	Unit
----------------	--------	-----------------	-----	-----	-----	------

OFF CHARACTERISTICS

Drain-to-Source Breakdown Voltage	BV _{DSS}	V _{GS} = 0 V, I _D = 1 mA	500			V
Breakdown Voltage Temperature Coefficient	ΔBV _{DSS} /ΔT _J	Reference to 25°C, I _D = 1 mA		0.6		V/°C
Drain-to-Source Leakage Current	I _{DSS}	V _{DS} = 500 V, V _{GS} = 0 V	25°C		1	μA
			150°C		50	
Gate-to-Source Forward Leakage	I _{GSS}	V _{GS} = ±20 V			±10	μA

ON CHARACTERISTICS (Note 5)

Static Drain-to-Source On-Resistance	R _{DS(on)}	V _{GS} = 10 V, I _D = 2.2 A		1.25	1.5	Ω
Gate Threshold Voltage	V _{GS(th)}	V _{DS} = V _{GS} , I _D = 50 μA	3.0		4.5	V
Forward Transconductance	g _{FS}	V _{DS} = 15 V, I _D = 2.5 A		3.5		S

DYNAMIC CHARACTERISTICS

Input Capacitance	C _{iss}	V _{DS} = 25 V, V _{GS} = 0 V, f = 1.0 MHz		530		pF
Output Capacitance	C _{oss}			68		
Reverse Transfer Capacitance	C _{rss}			15		
Total Gate Charge	Q _g	V _{DD} = 250 V, I _D = 5 A, V _{GS} = 10 V		18.5		nC
Gate-to-Source Charge	Q _{gs}			4		
Gate-to-Drain ("Miller") Charge	Q _{gd}			10		
Plateau Voltage	V _{GP}			6.5		
Gate Resistance	R _g			4.5		Ω

RESISTIVE SWITCHING CHARACTERISTICS

Turn-On Delay Time	t _{d(on)}	V _{DD} = 250 V, I _D = 5 A, V _{GS} = 10 V, R _G = 5 Ω		11		ns
Rise Time	t _r			15		
Turn-Off Delay Time	t _{d(off)}			24		
Fall Time	t _f			14		

SOURCE-DRAIN DIODE CHARACTERISTICS (T_C = 25°C unless otherwise noted)

Diode Forward Voltage	V _{SD}	I _S = 5 A, V _{GS} = 0 V			1.6	V
Reverse Recovery Time	t _{rr}	V _{GS} = 0 V, V _{DD} = 30 V		255		ns
Reverse Recovery Charge	Q _{rr}	I _S = 5 A, di/dt = 100 A/μs		1.25		μC

5. Pulse Width ≤ 380 μs, Duty Cycle ≤ 2%.

TYPICAL CHARACTERISTICS

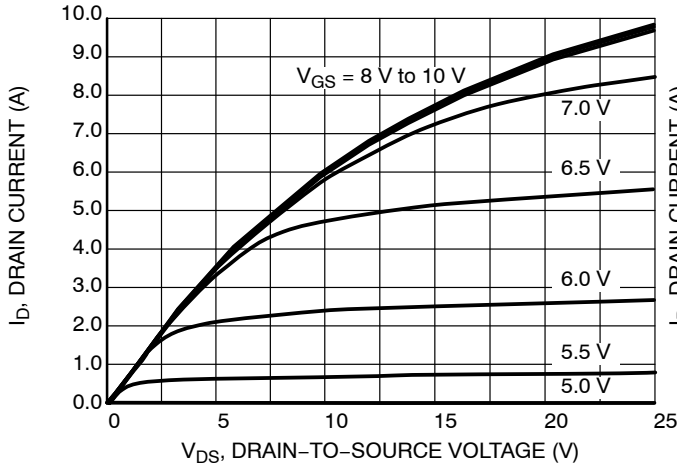

Figure 1. On-Region Characteristics

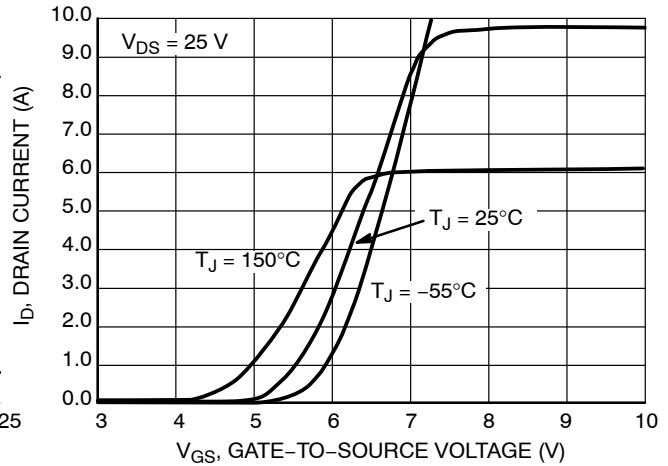

Figure 2. Transfer Characteristics

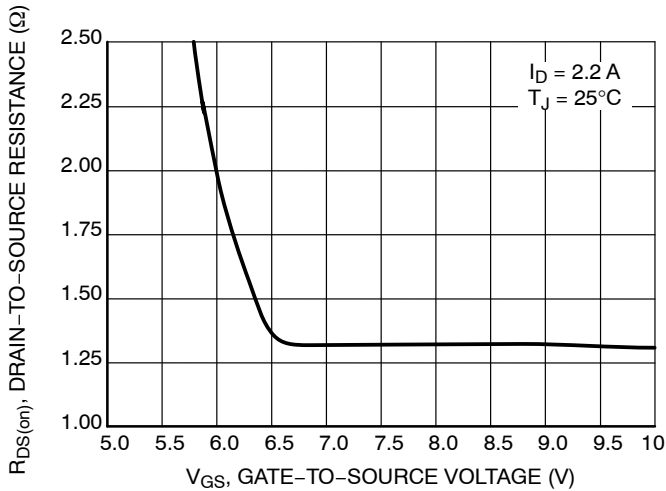

Figure 3. On-Region versus Gate-to-Source Voltage

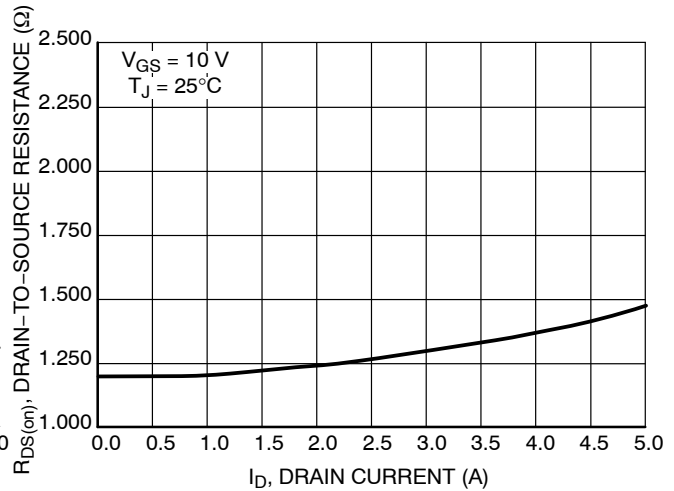

Figure 4. On-Resistance versus Drain Current and Gate Voltage

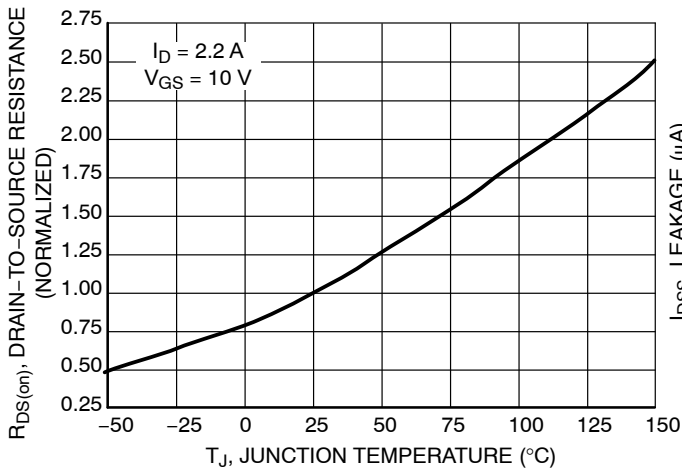

Figure 5. On-Resistance Variation with Temperature

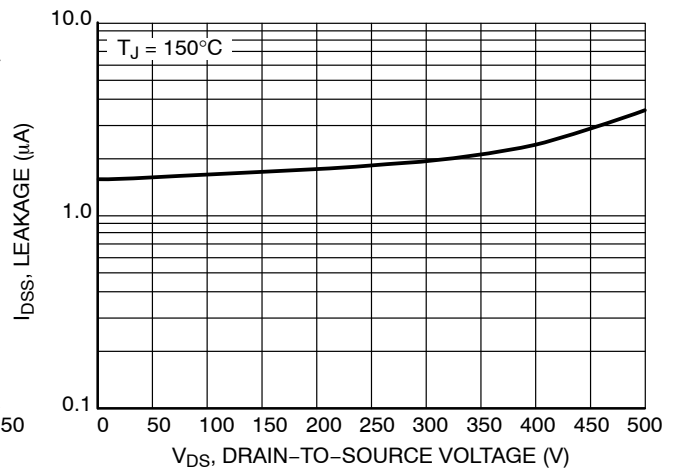

Figure 6. Drain-to-Source Leakage Current versus Voltage

NDF05N50Z, NDP05N50Z, NDD05N50Z

TYPICAL CHARACTERISTICS

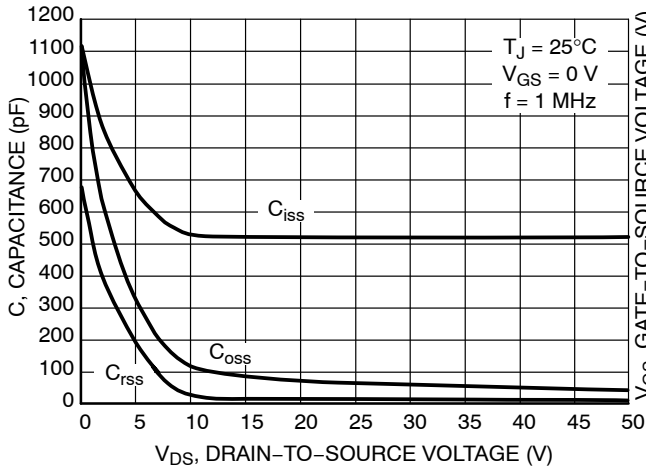

Figure 7. Capacitance Variation

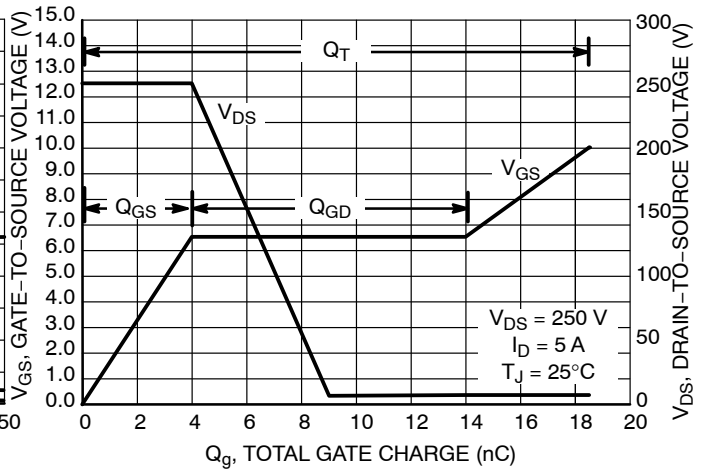

Figure 8. Gate-to-Source Voltage and Drain-to-Source Voltage versus Total Charge

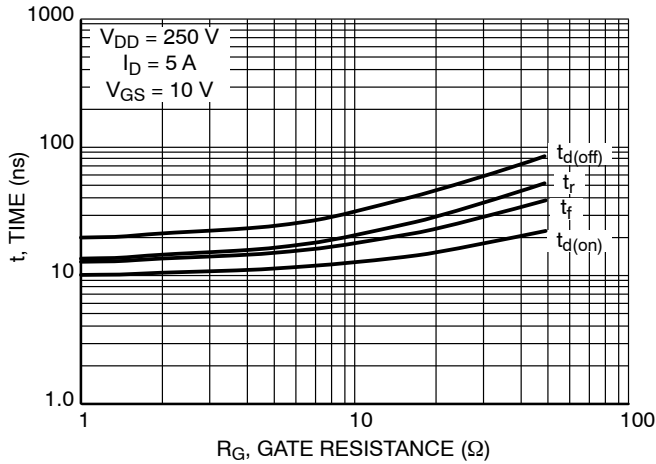

Figure 9. Resistive Switching Time Variation versus Gate Resistance

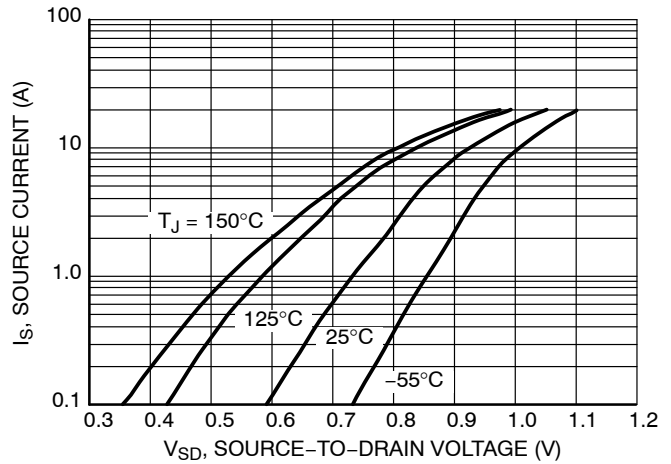

Figure 10. Diode Forward Voltage versus Current

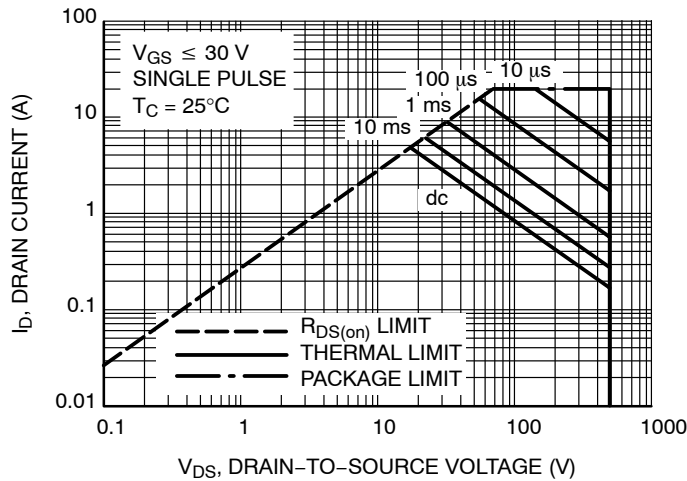

Figure 11. Maximum Rated Forward Biased Safe Operating Area NDD05N50Z

NDF05N50Z, NDP05N50Z, NDD05N50Z

TYPICAL CHARACTERISTICS

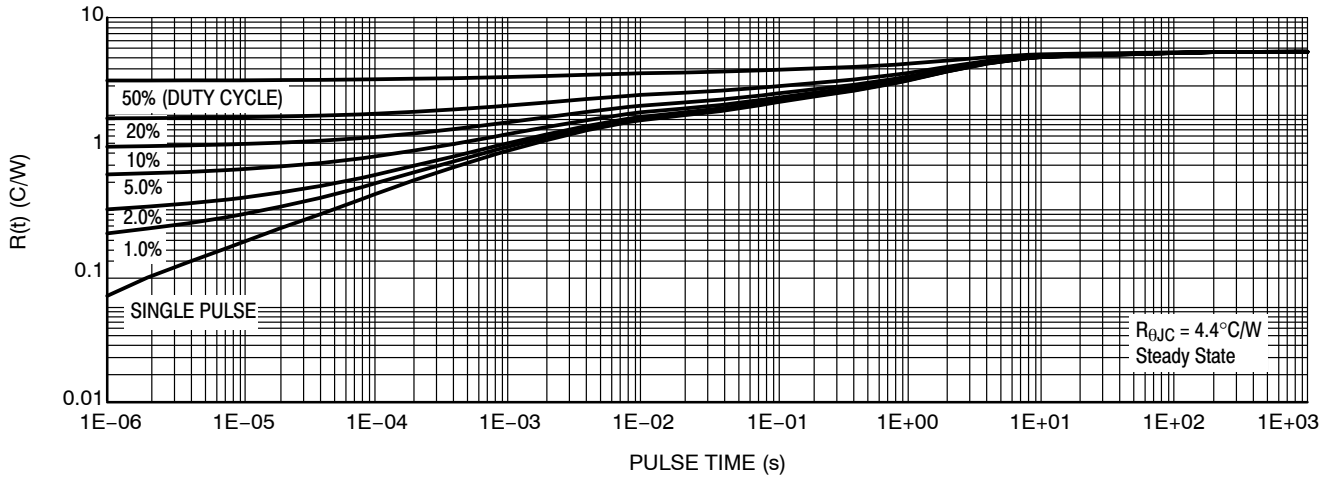

Figure 12. Thermal Impedance (Junction-to-Case) for NDF05N50Z

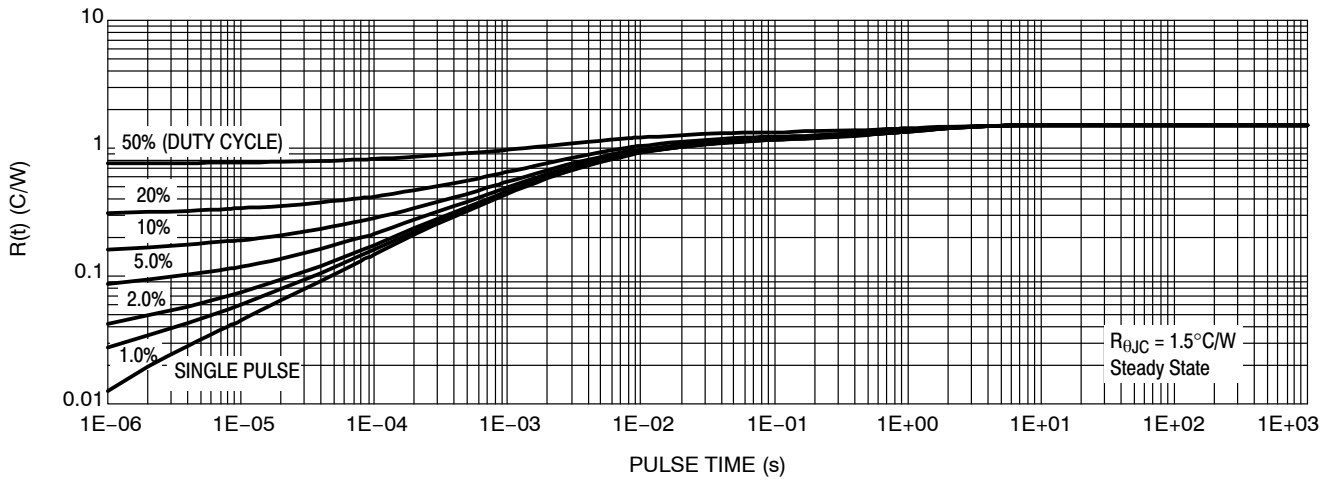

Figure 13. Thermal Impedance (Junction-to-Case) for NDD05N50Z

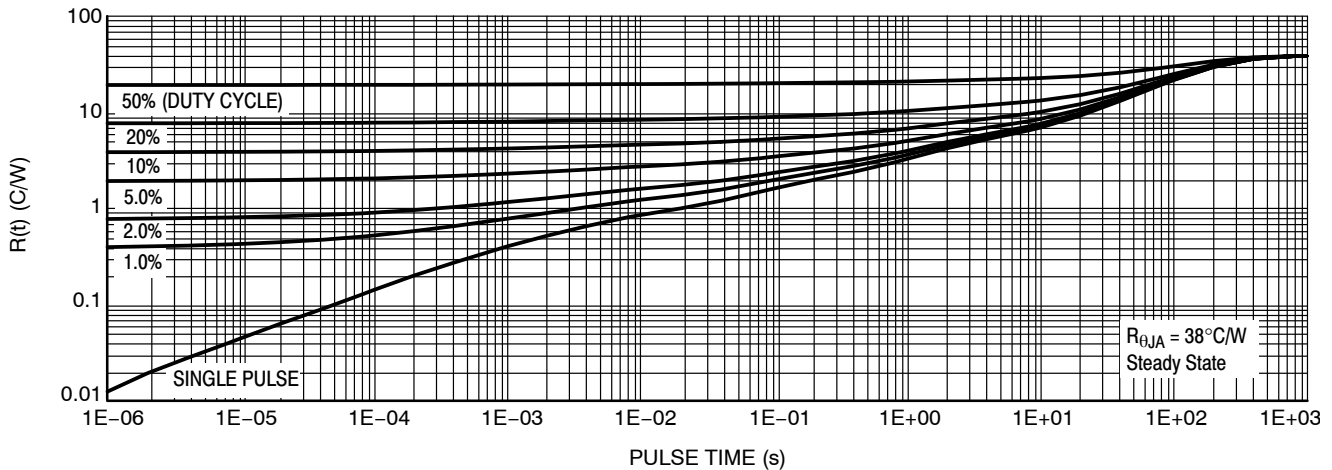

Figure 14. Thermal Impedance (Junction-to-Ambient) for NDD05N50Z

NDF05N50Z, NDP05N50Z, NDD05N50Z

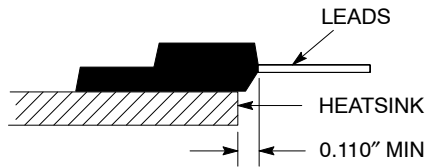

Figure 15. Mounting Position for Isolation Test

Measurement made between leads and heatsink with all leads shorted together.

ORDERING INFORMATION

Order Number	Package	Shipping†
NDF05N50ZG	TO-220FP (Pb-Free)	50 Units / Rail (In Development)
NDP05N50ZG	TO-220AB (Pb-Free)	50 Units / Rail (In Development)
NDD05N50Z-1G	IPAK (Pb-Free)	75 Units / Rail
NDD05N50ZT4G	DPAK (Pb-Free)	2500 / Tape & Reel

†For information on tape and reel specifications, including part orientation and tape sizes, please refer to our Tape and Reel Packaging Specifications Brochure, BRD8011/D.

MARKING DIAGRAMS

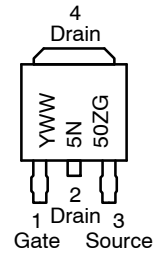
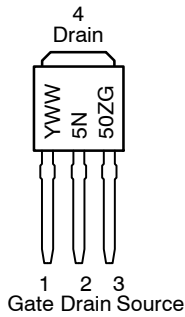
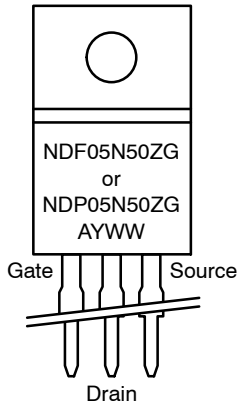

A = Location Code
 Y = Year
 WW = Work Week
 G = Pb-Free Package

NDF05N50Z, NDP05N50Z, NDD05N50Z

PACKAGE DIMENSIONS

TO-220 FULLPAK CASE 221D-03 ISSUE K

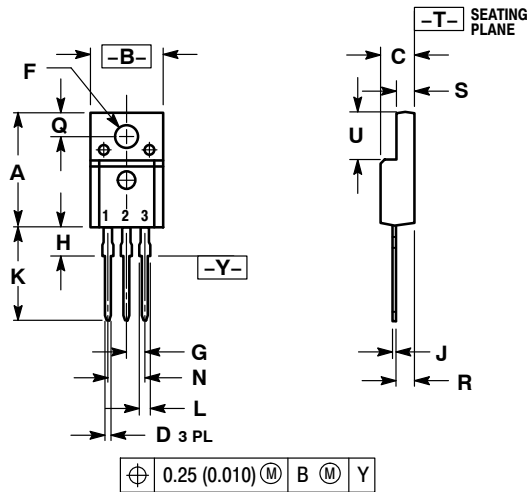

- NOTES:
1. DIMENSIONING AND TOLERANCING PER ANSI Y14.5M, 1982.
 2. CONTROLLING DIMENSION: INCH
 3. 221D-01 THRU 221D-02 OBSOLETE, NEW STANDARD 221D-03.

DIM	INCHES		MILLIMETERS	
	MIN	MAX	MIN	MAX
A	0.617	0.635	15.67	16.12
B	0.392	0.419	9.96	10.63
C	0.177	0.193	4.50	4.90
D	0.024	0.039	0.60	1.00
F	0.116	0.129	2.95	3.28
G	0.100 BSC		2.54 BSC	
H	0.118	0.135	3.00	3.43
J	0.018	0.025	0.45	0.63
K	0.503	0.541	12.78	13.73
L	0.048	0.058	1.23	1.47
N	0.200 BSC		5.08 BSC	
Q	0.122	0.138	3.10	3.50
R	0.099	0.117	2.51	2.96
S	0.092	0.113	2.34	2.87
U	0.239	0.271	6.06	6.88

- STYLE 1:
1. GATE
 2. DRAIN
 3. SOURCE

TO-220 CASE 221A-09 ISSUE AF

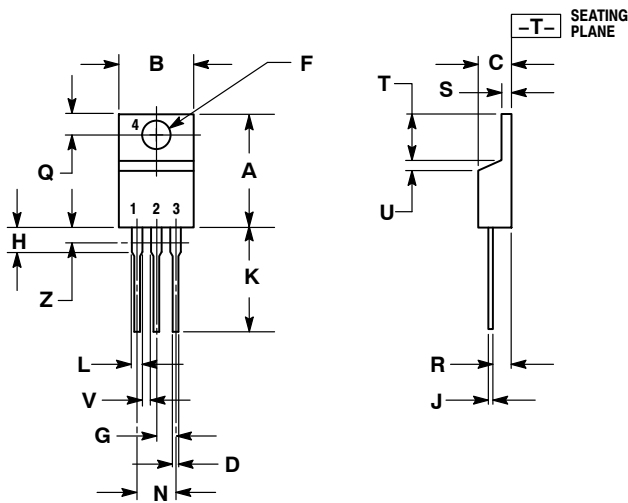

- NOTES:
1. DIMENSIONING AND TOLERANCING PER ANSI Y14.5M, 1982.
 2. CONTROLLING DIMENSION: INCH.
 3. DIMENSION Z DEFINES A ZONE WHERE ALL BODY AND LEAD IRREGULARITIES ARE ALLOWED.

DIM	INCHES		MILLIMETERS	
	MIN	MAX	MIN	MAX
A	0.570	0.620	14.48	15.75
B	0.380	0.405	9.66	10.28
C	0.160	0.190	4.07	4.82
D	0.025	0.035	0.64	0.88
F	0.142	0.161	3.61	4.09
G	0.095	0.105	2.42	2.66
H	0.110	0.155	2.80	3.93
J	0.014	0.025	0.36	0.64
K	0.500	0.562	12.70	14.27
L	0.045	0.060	1.15	1.52
N	0.190	0.210	4.83	5.33
Q	0.100	0.120	2.54	3.04
R	0.080	0.110	2.04	2.79
S	0.045	0.055	1.15	1.39
T	0.235	0.255	5.97	6.47
U	0.000	0.050	0.00	1.27
V	0.045	---	1.15	---
Z	---	0.080	---	2.04

- STYLE 5:
1. GATE
 2. DRAIN
 3. SOURCE
 4. DRAIN

NDF05N50Z, NDP05N50Z, NDD05N50Z

PACKAGE DIMENSIONS

DPAK CASE 369AA-01 ISSUE A

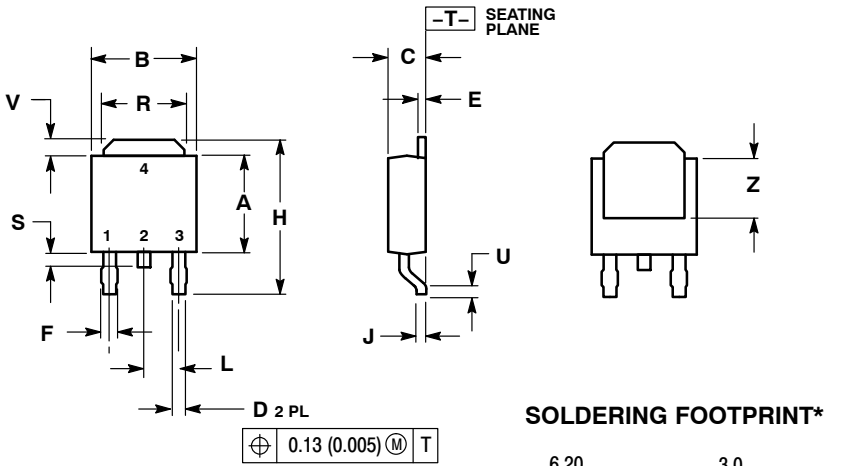

- NOTES:
1. DIMENSIONING AND TOLERANCING PER ANSI Y14.5M, 1982.
2. CONTROLLING DIMENSION: INCH.

DIM	INCHES		MILLIMETERS	
	MIN	MAX	MIN	MAX
A	0.235	0.245	5.97	6.22
B	0.250	0.265	6.35	6.73
C	0.086	0.094	2.19	2.38
D	0.025	0.035	0.63	0.89
E	0.018	0.024	0.46	0.61
F	0.030	0.045	0.77	1.14
H	0.386	0.410	9.80	10.40
J	0.018	0.023	0.46	0.58
L	0.090	BSC	2.29	BSC
R	0.180	0.215	4.57	5.45
S	0.024	0.040	0.60	1.01
U	0.020	---	0.51	---
V	0.035	0.050	0.89	1.27
Z	0.155	---	3.93	---

SOLDERING FOOTPRINT*

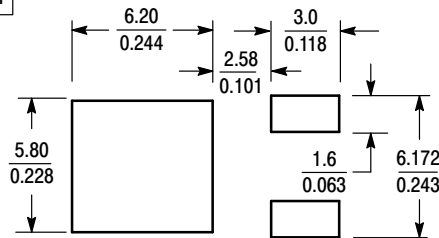

- STYLE 2:
PIN 1. GATE
2. DRAIN
3. SOURCE
4. DRAIN

SCALE 3:1 $\left(\frac{\text{mm}}{\text{inches}}\right)$

*For additional information on our Pb-Free strategy and soldering details, please download the ON Semiconductor Soldering and Mounting Techniques Reference Manual, SOLDERRM/D.

IPAK CASE 369D-01 ISSUE B

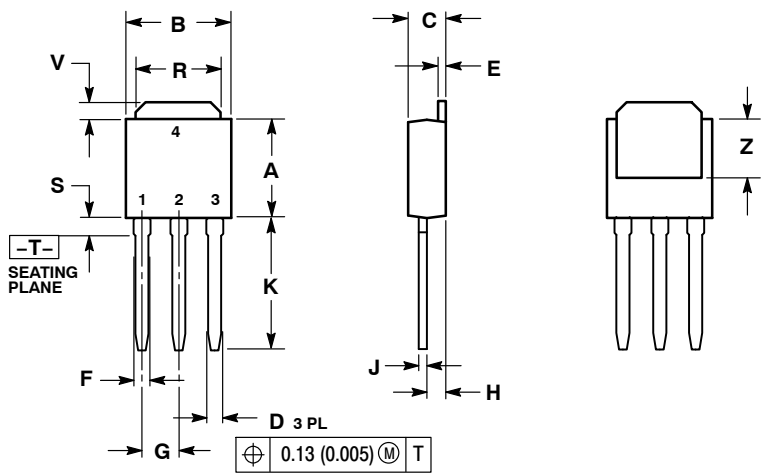

- NOTES:
1. DIMENSIONING AND TOLERANCING PER ANSI Y14.5M, 1982.
2. CONTROLLING DIMENSION: INCH.

DIM	INCHES		MILLIMETERS	
	MIN	MAX	MIN	MAX
A	0.235	0.245	5.97	6.35
B	0.250	0.265	6.35	6.73
C	0.086	0.094	2.19	2.38
D	0.027	0.035	0.69	0.88
E	0.018	0.023	0.46	0.58
F	0.037	0.045	0.94	1.14
G	0.090	BSC	2.29	BSC
H	0.034	0.040	0.87	1.01
J	0.018	0.023	0.46	0.58
K	0.350	0.380	8.89	9.65
R	0.180	0.215	4.45	5.45
S	0.025	0.040	0.63	1.01
V	0.035	0.050	0.89	1.27
Z	0.155	---	3.93	---

- STYLE 2:
PIN 1. GATE
2. DRAIN
3. SOURCE
4. DRAIN

ON Semiconductor and  are registered trademarks of Semiconductor Components Industries, LLC (SCILLC). SCILLC reserves the right to make changes without further notice to any products herein. SCILLC makes no warranty, representation or guarantee regarding the suitability of its products for any particular purpose, nor does SCILLC assume any liability arising out of the application or use of any product or circuit, and specifically disclaims any and all liability, including without limitation special, consequential or incidental damages. "Typical" parameters which may be provided in SCILLC data sheets and/or specifications can and do vary in different applications and actual performance may vary over time. All operating parameters, including "Typicals" must be validated for each customer application by customer's technical experts. SCILLC does not convey any license under its patent rights nor the rights of others. SCILLC products are not designed, intended, or authorized for use as components in systems intended for surgical implant into the body, or other applications intended to support or sustain life, or for any other application in which the failure of the SCILLC product could create a situation where personal injury or death may occur. Should Buyer purchase or use SCILLC products for any such unintended or unauthorized application, Buyer shall indemnify and hold SCILLC and its officers, employees, subsidiaries, affiliates, and distributors harmless against all claims, costs, damages, and expenses, and reasonable attorney fees arising out of, directly or indirectly, any claim of personal injury or death associated with such unintended or unauthorized use, even if such claim alleges that SCILLC was negligent regarding the design or manufacture of the part. SCILLC is an Equal Opportunity/Affirmative Action Employer. This literature is subject to all applicable copyright laws and is not for resale in any manner.

PUBLICATION ORDERING INFORMATION

LITERATURE FULFILLMENT:

Literature Distribution Center for ON Semiconductor
P.O. Box 5163, Denver, Colorado 80217 USA
Phone: 303-675-2175 or 800-344-3860 Toll Free USA/Canada
Fax: 303-675-2176 or 800-344-3867 Toll Free USA/Canada
Email: orderlit@onsemi.com

N. American Technical Support: 800-282-9855 Toll Free
USA/Canada
Europe, Middle East and Africa Technical Support:
Phone: 421 33 790 2910
Japan Customer Focus Center
Phone: 81-3-5773-3850

ON Semiconductor Website: www.onsemi.com
Order Literature: <http://www.onsemi.com/orderlit>
For additional information, please contact your local
Sales Representative